

Article number: 12757000035120
Description: KLEE-coil 757 000 035.120
M3,5 Steel, zinc-pl. & chr. yellow

Measures

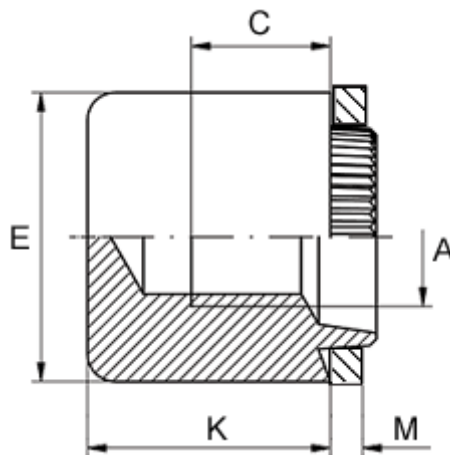

Female thread A	= M3,5
Height K	= 9.0
Min thread length C	= 4.0
Outer diameter E	= 10.0
Plate thickness	= 4.7 to 4.9
Recommended bore diameter for extreme load	= 7.0
Recommended bore diameter for normal use	= 7.0